

## DATASHEET

## GSM Mono Series

Model Number	Pm(W)	Vmp(V)	Imp(A)	Voc(V)	Isc(A)	Module Efficiency(%)	Weight(KGS)	Dimension(MM)
GSM-12W-M	12	17.9	0.67	22.2	0.75	12.12	1.2	330×300×17
GSM-15W-M	15	17.8	0.85	22.1	0.96	12.46	1.8	430×280×17
GSM-25W-M	25	18.0	1.39	22.3	1.53	13.10	2.3	530×360×25
GSM-35W-M	35	17.8	1.97	22.0	2.19	12.74	3.3	670×410×25
GSM-50W-M	50	18.3	2.74	22.3	2.98	13.77	4.2	660×550×25
GSM-80W-M	80	18.4	4.35	22.4	4.74	15.51	6.0	770×670×25
GSM-100W-M	100	18.1	5.52	22.6	6.27	15.15	8.2	1200×550×25
Nominal Operating Cell Temperature(NOCT)								45 ± 2 °C
Temperature Coefficient Of Pmax(%/°C)								-0.37
Temperature Coefficient Of Voc(%/°C)								-0.32
Temperature Coefficient Of Isc(%/°C)								0.09
Operating Temperature								-40~+85 °C
Storage Temperature								-40~+85 °C
Frame Model							Anodized Aluminum Alloy	
Solar Cells							Monocrystalline	
Glass							Low Iron, Tempered Glass, 3.2 mm	
Connector							Optional	
Cable							Optional	

### I-V CURVES GSM-50W-M

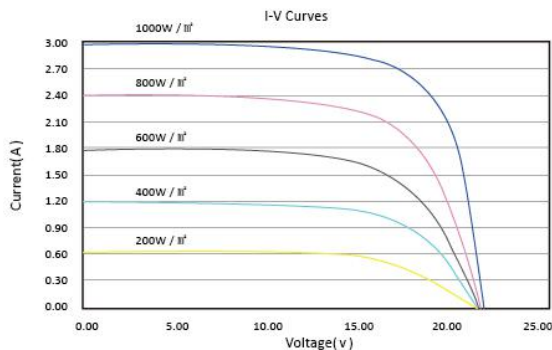

- 5-year product warranty
- 12-year linear power output warranty

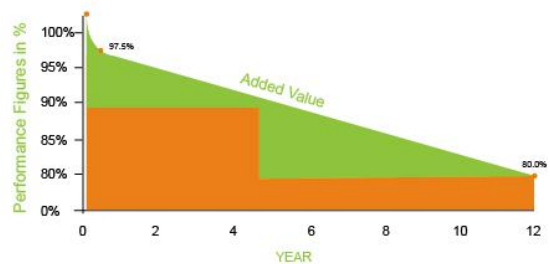

CAUTION: Great Solar reserves all rights. Design and specification are subject to change without prior notice.

# LG GREAT SOLAR

Power Your Future

GSM Mono Series

## PRODUCT DRAWING

GSM-12W-M

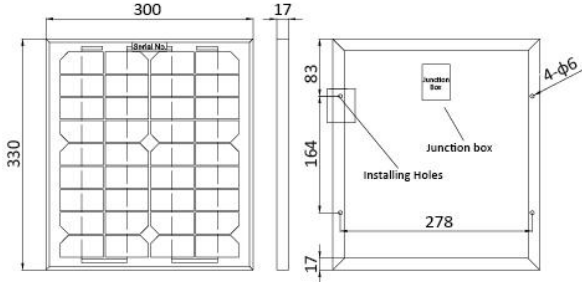

GSM-15W-M

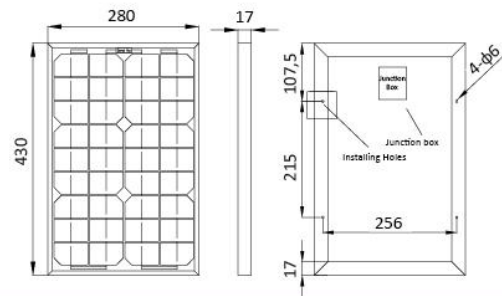

GSM-25W-M

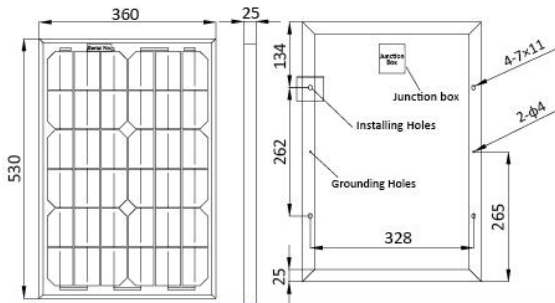

GSM-35W-M

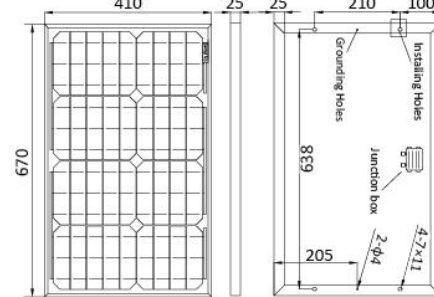

GSM-50W-M

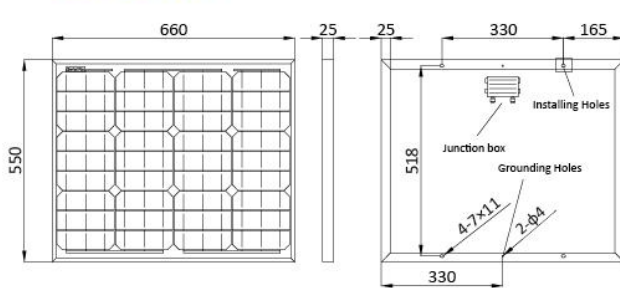

GSM-80W-M

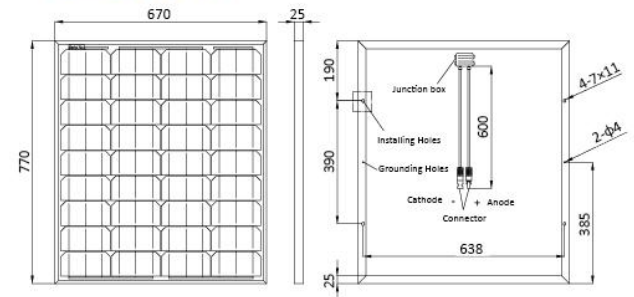

GSM-100W-M

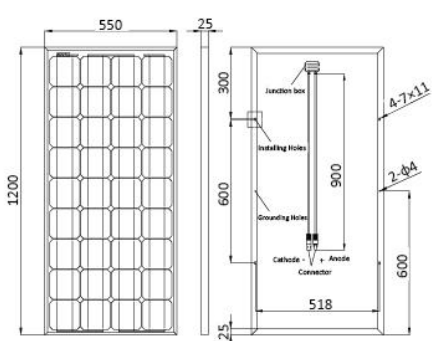

φ4

## DATASHEET

## GSM Mono Series

Model Number	Pm(W)	Vmp(V)	Imp(A)	Voc(V)	Isc(A)	Module Efficiency(%)	Weight(KGS)	Dimension(MM)
GSM-130W-M	130	18.5	7.03	22.6	7.94	15.50	9.50	1252×670×30
GSM-140W-M	140	18.3	7.65	22.3	8.22	15.83	10.0	1320×670×30
GSM-160W-M	160	18.5	8.65	22.6	9.73	16.14	11.2	1480×670×30
GSM-210W-M	210	26.4	7.96	32.9	8.84	16.04	15.5	1320×992×35
GSM-240W-M	240	28.5	8.43	34.8	9.30	16.35	17.0	1480×992×35
Nominal Operating Cell Temperature(NOCT)								45 ± 2 °C
Temperature Coefficient Of Pmax(%/°C)								-0.37
Temperature Coefficient Of Voc(%/°C)								-0.32
Temperature Coefficient Of Isc(%/°C)								0.09
Operating Temperature								-40~+85 °C
Storage Temperature								-40~+85 °C
Frame Model							Anodized Aluminum Alloy	
Solar Cells							Monocrystalline	
Glass							Low Iron, Tempered Glass, 3.2 mm	
Connector							Optional	
Cable							Optional	

### I-V CURVES GSM-240W-M

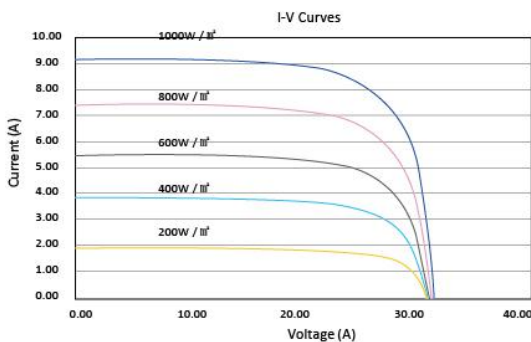

- 5-year product warranty
- 12-year linear power output warranty

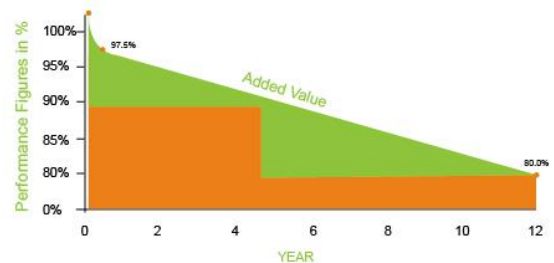

CAUTION: Great Solar reserves all rights. Design and specification are subject to change without prior notice.

# LG GREAT SOLAR

Power Your Future

GSM Mono Series

## PRODUCT DRAWING

GSM-130W-M

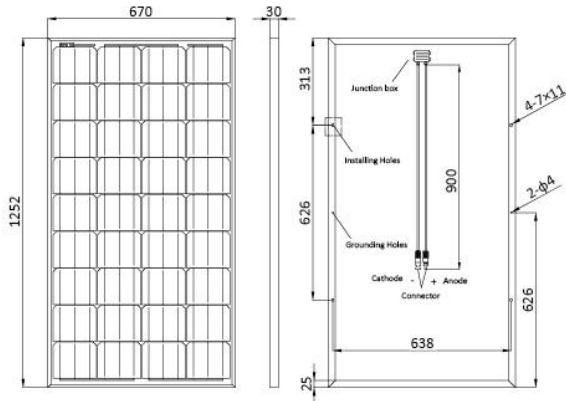

GSM-140W-M

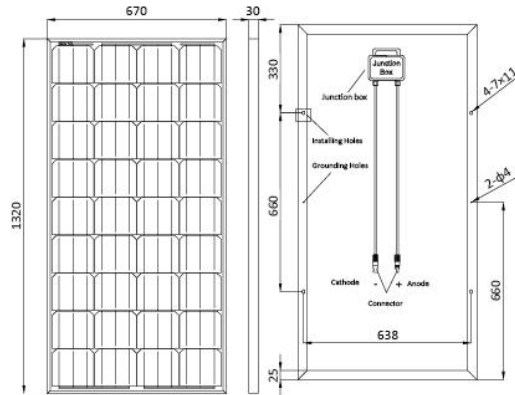

GSM-160W-M

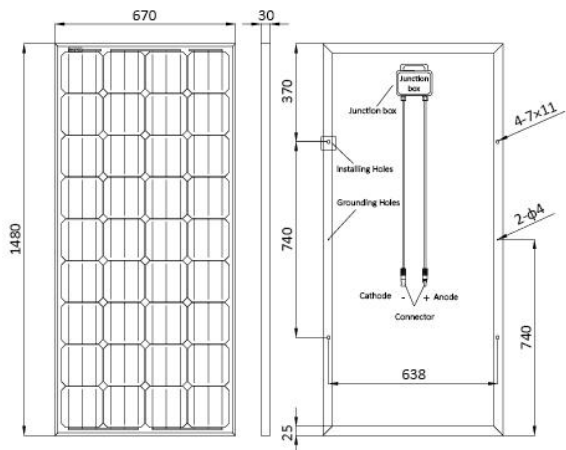

GSM-210W-M

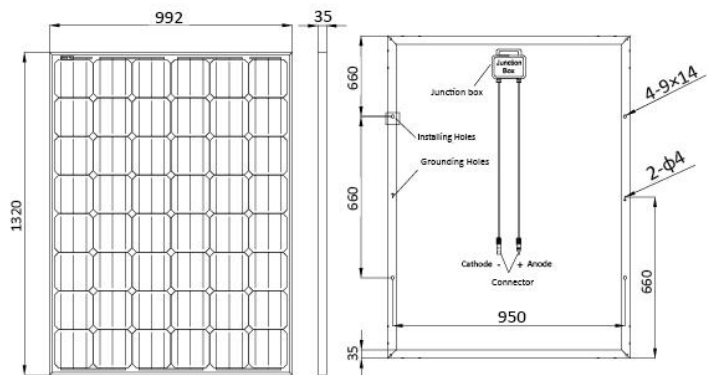

GSM-240W-M

